

TS 4000  
TS 4000 S



107754-03

**GEZE**



**A**

**B**

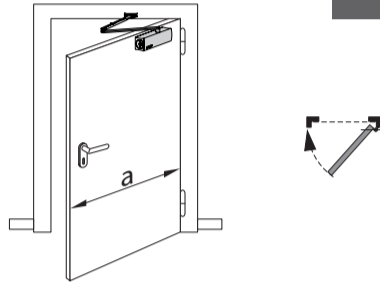
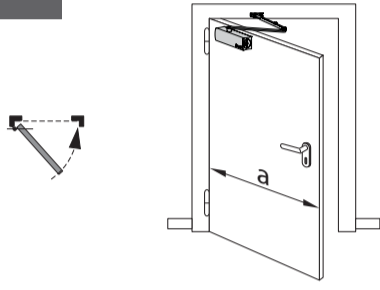

TS 4000/4000 S  $a \leq 1400$  mm  
TS 4000 EN 5-7  $a \leq 1600$  mm

TS 4000/4000 S  $a \leq 1400$  mm  
TS 4000 EN 5-7  $a \leq 1600$  mm

**1**

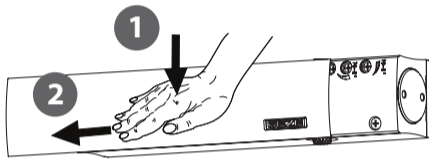

**2**

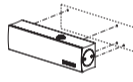
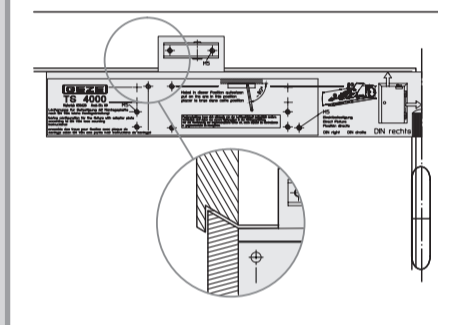
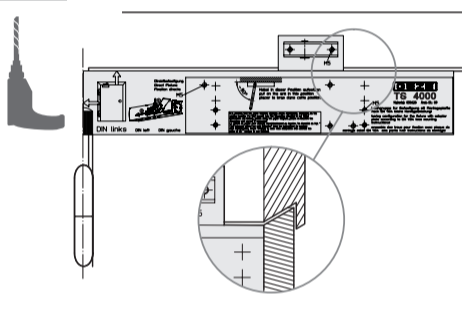

[mm]

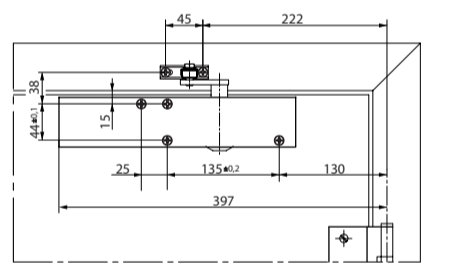
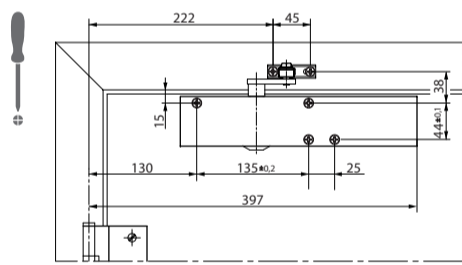

4x  
5x60  
4x  
M5x55

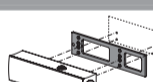

[mm]

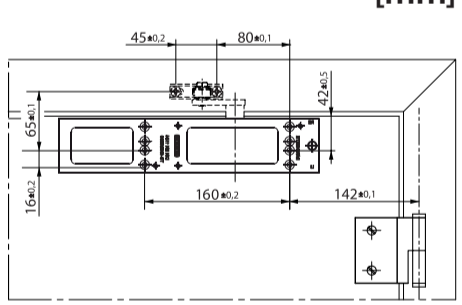
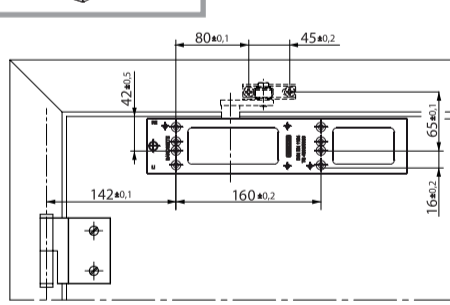

4x  
5x35  
4x  
M5x20

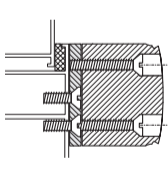
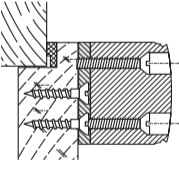

3x  
M5x45

**3**

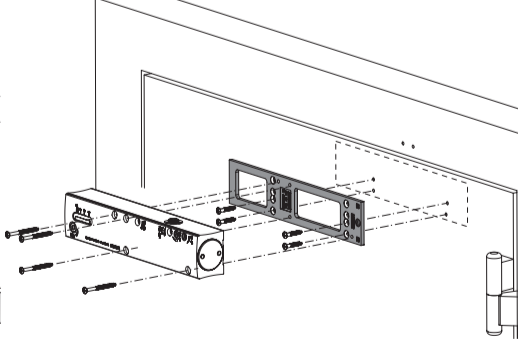
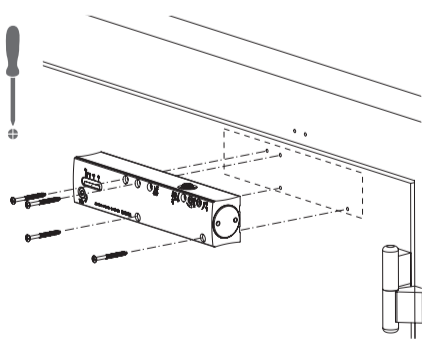

**4**

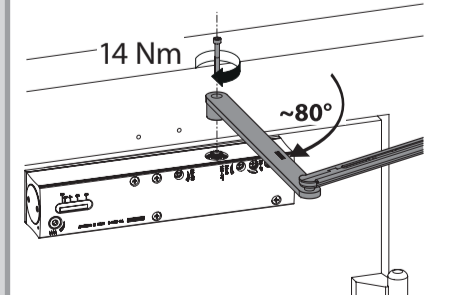
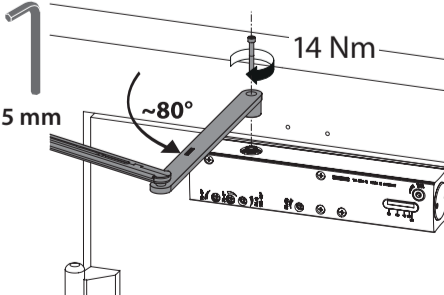

**5**

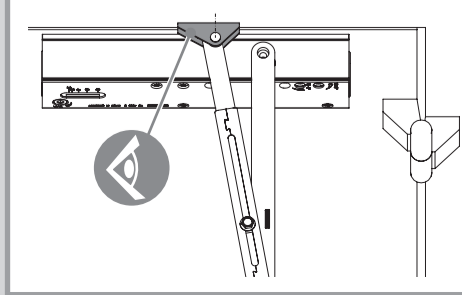
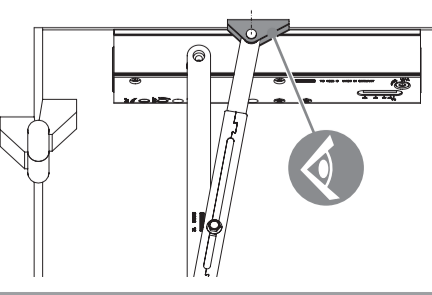

6



10 mm

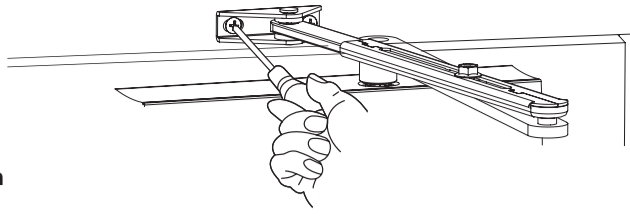

2x 5x20  
2x M5x16

**i+** TS 4000

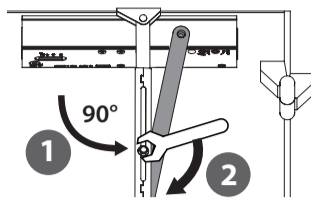
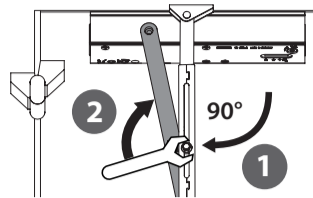
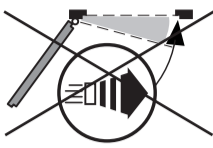
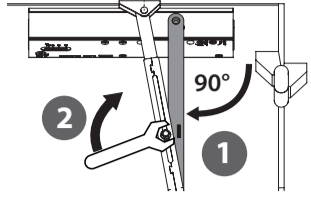
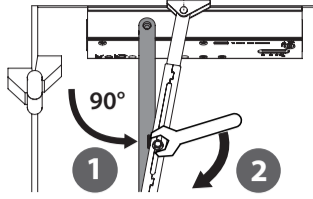

**i+** TS 4000 S

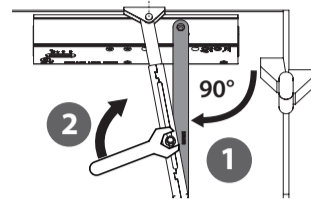
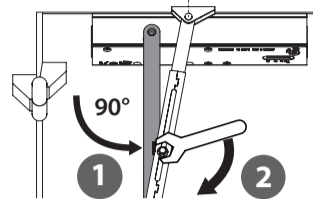

7



5 mm

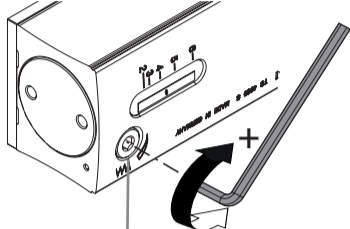
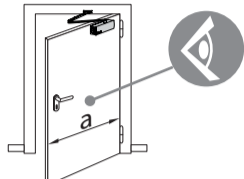

a (mm) - EN

1600	- 7
1400	- 6
1250	- 5
1150	- 4
950	- 3
850	- 2
750	- 1

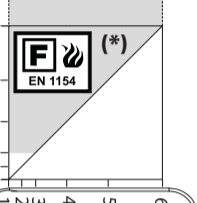

(\*) = + ≥ EN 3

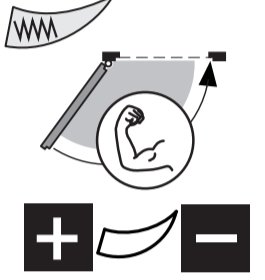

8

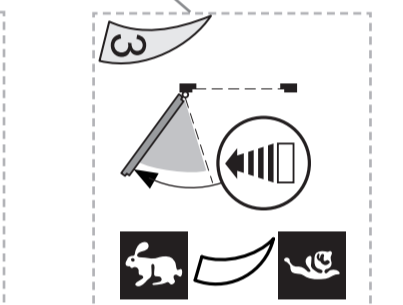
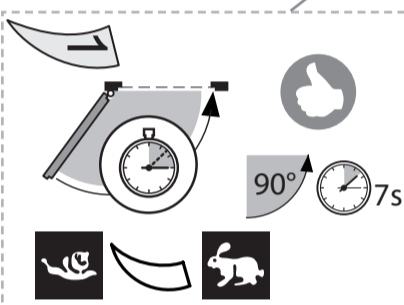

**i+** TS 4000 S

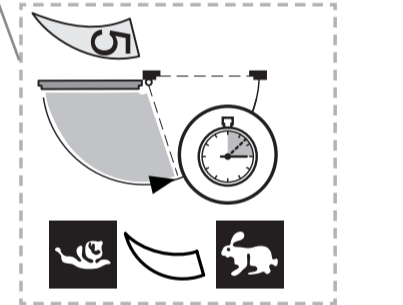
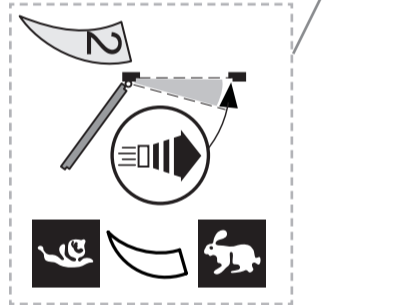
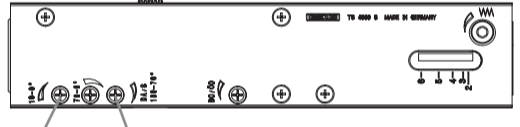

9

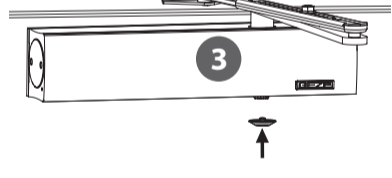
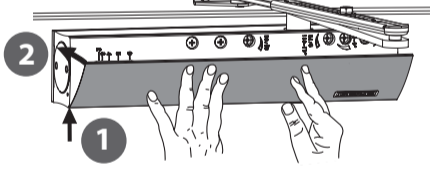

**i**

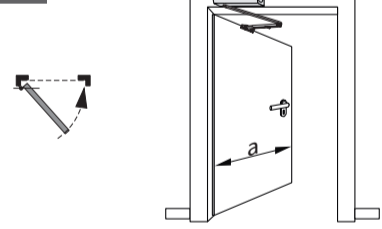

TS 4000/4000 S a ≤ 1400 mm  
TS 4000 EN 5-7 a ≤ 1600 mm

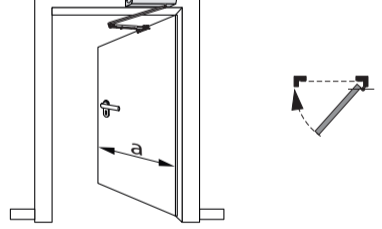

TS 4000/4000 S a ≤ 1400 mm  
TS 4000 EN 5-7 a ≤ 1600 mm

